

What is YIG?

Yttrium Iron Garnet (YIG) is a crystal that has very high Q characteristics. This high Q provides very low phase noise in oscillators and multi-octave frequency tuning for both oscillators and filters.

YIG crystals are “grown”, similar to silicon crystals. The pulled crystal is “sliced and diced”, resulting in small YIG cubes. (Unfortunately, the cube shape is non-uniform, and as a result has non-uniform coupling in a resonator circuit.) These small YIG cubes are then put into a “tumbler” that slowly shape the YIG cube into a YIG sphere (very similar to smoothing a stone for jewelry). The size of the YIG spheres range from 10-30 mils.

The YIG sphere is typically mounted on the end of a thermally conductive rod (normally beryllium). This is done for two reasons: 1) the rod acts as a “tuning stick” for orienting the YIG sphere in the resonant circuit, and 2) YIG has best performance when it’s temperature is kept constant; the rod is a thermal conductor to/from a proportional heater and the YIG sphere. (YIG oscillators and filters have been designed without the rod and heater for low cost. However, the impact on performance limits applications.)

How Does YIG Work?

YIG is a ferrite material that resonates at microwave frequencies when immersed in a DC magnetic field. This resonance is directly proportional to the strength of the applied magnetic field and has very linear “tuning” over multi-octave microwave frequencies.

The DC magnetic field is generated using an electromagnet, a permanent magnet, or a combination of both. The magnetic field of an electromagnet can be “tuned” using a variable current. Figure 1 illustrates a typical YIG oscillator magnet.

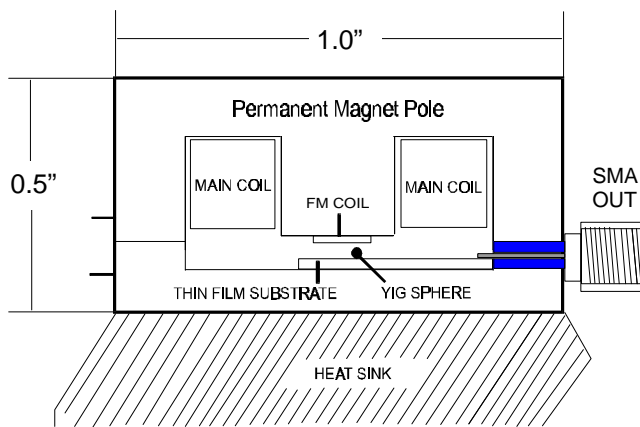

Fig. 1: Typical YIG-tuned PMO cross section.

YIG crystal resonance is the alignment of external electron paths at the molecular level (precession), creating a “combined” magnetic dipole: *a magnetic field resonating at microwave frequencies around the YIG sphere.*

How Do We Use YIG?

Current generates magnetic fields, and magnet fields can generate current when coupled to a conductive “loop”. Using small conductive “loops” allows coupling **to & from** the YIG spheres resonant magnetic field (see figure 2).

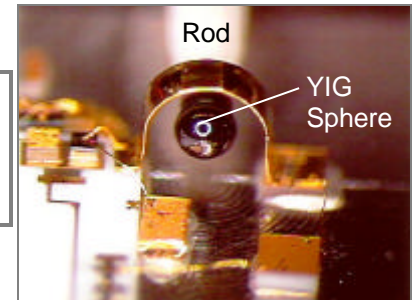

Fig. 2: Conductive loop over a YIG sphere for oscillator application.

There are three basic methods in which this coupling is applied:

- Oscillation-Feedback
- Signal Transfer, & Rejection (see Filters)

Oscillation-Feedback

Oscillation-Feedback is used to generate variable inductance/capacitance in common gate, common base or common source oscillator “tank” circuits (see figure 3).

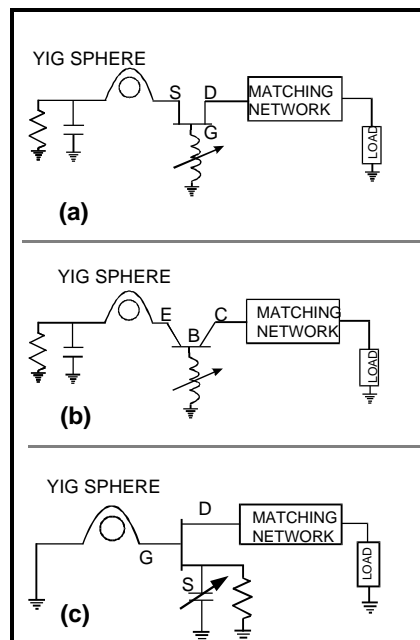

Fig. 3: Feedback topology for the (a) common-gate FET, (b) common-base bipolar and (c) common-source FET configurations.

Common-Gate FET Oscillator

The common-gate FET oscillator circuit is the most common YIG oscillator topology. It provides wide tuning bandwidth (e.g. 2-8 GHz, 6-18 GHz & 20-40 GHz) and can achieve frequencies in excess of 50 GHz. Although the common-gate FET YIG oscillator has better phase noise than most other technologies (e.g. VCOs and DROs), it does not provide optimum phase noise: typically 12 db higher/worse than the common base bipolar YIG oscillator (see Figure 4). (It should be noted that with the advent of inexpensive frequency doublers, YIG oscillator manufacturers have discontinued making fundamental oscillators above 26.5 GHz.)

Common-Base Bipolar Oscillator

The common-base bipolar YIG oscillator is the lowest phase noise microwave/millimeter wave (non-cryogenic) oscillator. It also provides wide tuning bandwidth (e.g. 2-8 GHz). Phase noise performance is approximately 12 db better than the common-gate FET oscillator. For millimeter wave radio applications, frequency multiplication of a Bipolar YTO provides better phase noise than a fundamental FET oscillator (see Figure 4).

Present bipolar transistors are available to 14 GHz. Higher frequencies are being designed and are continually tested by Micro Lambda for use in future oscillator circuits.

Common-Source FET Oscillator

The common-source FET YIG oscillator was developed for low phase noise applications above 14 GHz. Although it has phase noise of ~8 db higher than the common-base bipolar YIG oscillator (see Figure 4), and has limited tuning bandwidth (~5 GHz), it is a good economic solution for narrowband applications 14-24 GHz.

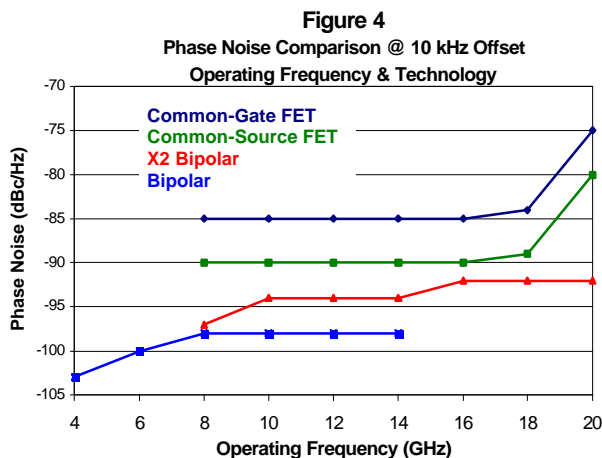

YIG Oscillator Specifications

There are four basic specification categories for YIG oscillators: RF, magnet, power consumption and environmental conditions. They are all somewhat interdependent and define unit performance and cost.

RF Specifications:

AM Noise

The random and/or systematic variations in output power amplitude. Usually expressed in terms of dBc in a specified video bandwidth at a specified frequency removed from the carrier.

Frequency Range

This is the desired frequency range of operation (including guard bands/margin). This specification will dictate the use of a permanent or electromagnet structure.

Frequency Accuracy

The maximum output frequency deviation from a specified tuning function under specified conditions. May be expressed in %, MHz, ppm or ppm/°C.

Frequency Drift Over Operating Temperature

The maximum change in output frequency as a result of a specified change in operating temperature.

Frequency Pulling

The difference between the maximum and minimum values of the oscillator frequency when the phase angle of the load impedance reflection coefficient varies through 360°. Typically this load impedance has a VSWR of 1.67:1.

Frequency Pushing

The incremental output frequency change produced by an incremental change in supply voltage (MHz/V). If supply voltage ripple, frequency range, and amplitude are not specified, measurements will be conducted at a DC rate.

Harmonic Signals

Signals which are coherently related to the output frequency. In general these signals are integer multiples of the output frequency, except for doubling oscillators

Incidental FM

The peak to peak variations of the carrier frequency due to external variations with the unit operating at a fixed frequency at any point in the tunable frequency range.

Phase Noise (FM Noise)

Phase noise is energy generated at frequencies other than the carrier/center frequency. Phase noise is measured as power relative to the carrier/center frequency, in frequency "windows" offset from the carrier/center frequency (see Figure 5).

Power Output, Max.

The maximum output power at all output frequencies within the oscillator tunable bandwidth under all specified conditions.

Power Output, Min.

The minimum output power at the output frequency within the tunable range under all specified conditions. Usually the specified conditions are temperature and load VSWR.

Power Output Variation

The maximum peak to peak power variation at all output frequencies in the tunable frequency range under all specified conditions.

Spurious Outputs

Undesirable signal outputs which may be harmonically and/or non-harmonically related to the fundamental output. Their tolerable amplitude should be specified in dB below the carrier within and out of the frequency range of the oscillator.

Magnet Specifications:

The magnet generates a DC magnetic field using an electromagnet, a permanent magnet, or a combination of both. The magnetic field of an electromagnet can be "tuned" using a variable current.

The electromagnet offers very linear, multi-octave tuning (e.g. 2-8 GHz). However, it requires considerable current to achieve higher frequencies. A typical 8-18 GHz YIG oscillator has a main tuning coil sensitivity of 20 MHz/mA; therefore the required tuning current at 8 GHz is: $8 \text{ GHz} / (20 \text{ MHz/mA}) = 400 \text{ mA}$, at 18 GHz it is 900 mA.

The permanent magnet is tuned at the factory to a customer selected free running frequency. A small main tuning coil is used to tune the oscillator up and/or down from the free running frequency. The permanent magnet has limited tuning bandwidth of approximately $\pm 2 \text{ GHz}$.

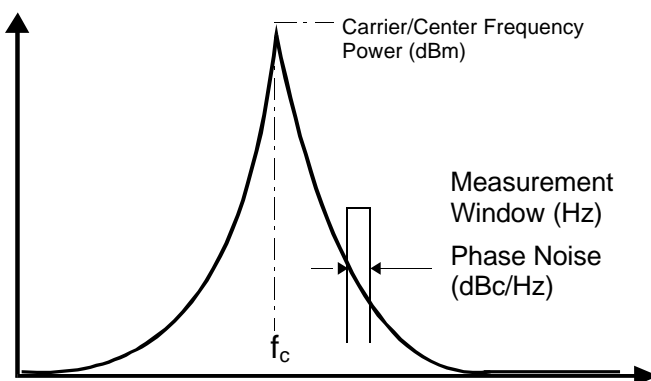

FIGURE 5. Phase Noise Measurement

Both the electromagnet and permanent magnet are available with FM tuning coils for phase locking applications.

Coil Inductance

The tuning coil inductance as measured on an impedance bridge at a specified test frequency.

Coil Resistance

The tuning coil resistance as measured on an ohm meter.

Hysteresis

The maximum differential (in MHz) of the center frequency (at a fixed coil current) seen when the YIG filter is tuned in both directions through the operating frequency range.

Linearity

The maximum output frequency deviation measured in MHz or % from a best fit straight line approximation of the tuning curve under constant temperature conditions. See Figure 6.

Figure 6. Linearity as defined by maximum deviation from best fit straight line.

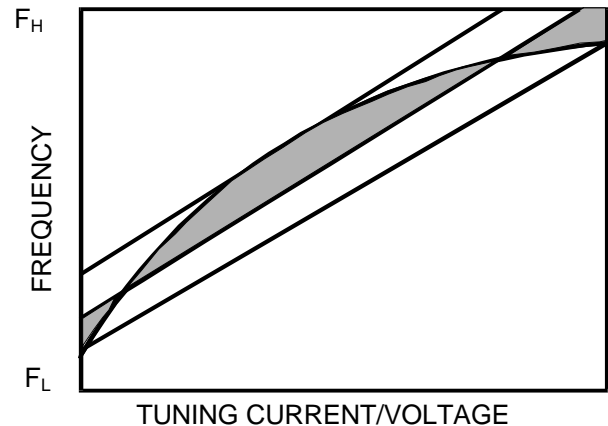
Magnetic Susceptibility

The output frequency deviation due to magnetic field measured in KHz/Gauss.

Modulation Response Bandwidth

The modulation frequency bandwidth (3dB) where for a reference deviation bandwidth reduced to the tuning sensitivity is .707 (3 dB point) of the DC sensitivity.

Post-Tuning Drift (PTD)

The maximum change in frequency (f_{PTD}) from the frequency measured at the beginning of the time interval (t_1). The time interval (t_1-t_2) shall be referenced to the application of a tuning command (t_0). The period of measurement ends at time (t_2). See Figure 7.



Figure 7. Frequency response of a YIG oscillator to a step change in tuning current/voltage.

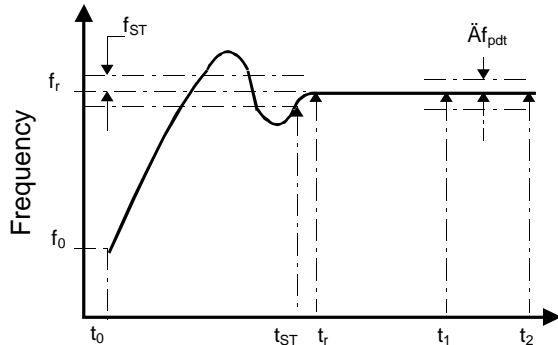

Where t_0 = time tune command is applied

Settling Time

The time (t_{ST}) required for the output frequency to enter and stay within a specified error bank ($\pm f_{ST}$) centered around a reference frequency (f_r) after application of a step input current. The time (t_r) shall be specified for determining the reference frequency (f_r). The period of measurement ends at the reference time (t_r). See Figure 7.

Tuning Sensitivity

The slope of the tuning curve in MHz/mA.

Tuning Input Impedance

The small signal impedance seen at the tuning input port at a specified modulation frequency of frequencies.

Power Consumption Specifications:

There are three basic power consumption areas: circuit biasing, YIG sphere heater and tuning current. Tuning current is addressed in the "Magnet Specifications" of this data sheet, and is in addition power to those described below.

Circuit Biasing

The YIG RF circuit is typically biased using a DC voltage from between +8 Vdc to +15 Vdc, drawing approximately 100 mA (High output power units require additional current). Some bipolar YIG RF circuits require a -5 Vdc bias, typically drawing 30 mA current.

Heater Current

Proportional heaters are normally used in YIG devices to keep the temperature of the YIG sphere constant (~+85° C). This improves RF performance, particularly spurious outputs.

Heater Current, Steady State

Heater current requirements during normal operations after reaching steady state conditions.

Heater Current, Surge

The peak current the heaters will draw upon initial power up.

Environmental Specifications

Environmental specifications define the operating and non-operating extremes that the YIG oscillator must operate, or withstand without damage.

Altitude-Operating

The altitudes (measured in feet or meters) that the YIG oscillator can operate while meeting all specifications.

Humidity-Operational

The relative humidity (compared to 100% saturation) measured in %, at a specific temperature.

Shock-Non-Operational

Is the magnitude of a short term impact (measured in Gs/mSec) that the non-operational YIG oscillator can survive without damage.

Temperature Range-Operating

The range of temperature as measured near the oscillator mounting surface over which the operating oscillator must meet all specifications, unless otherwise noted.

Temperature Range-Storage

The range of temperature that the YIG oscillator can be exposed to, non-operational, without damage.

Vibration-Operational

Is the frequency modulated (random or sinusoidal) G force that the oscillator can meet the specifications. See incidental FM in the RF Specifications section of this data sheet.

Vibration-Non-Operational

Is the frequency modulated (random or sinusoidal) G force that the non-operating YIG oscillator can withstand without damage.

Warm-Up Time

The minimum time required for the unit to meet all specifications.